

Varenummer: 03450200
 Beskrivelse: Fluro Heavy Duty Ledleje GE 200 AWE
 Hul Ø200
 Note: 200

Mål

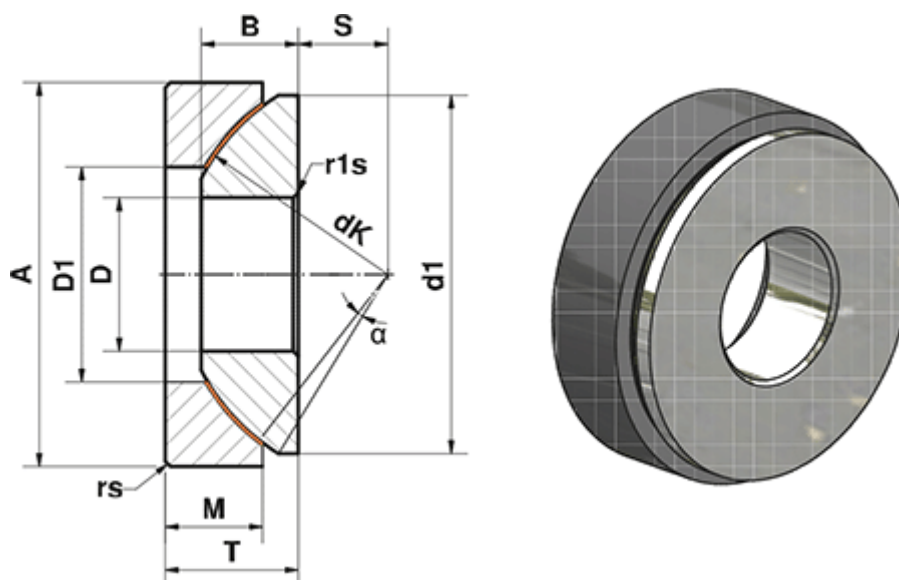

A	= 240	M	= 66
a (grader)	= 1	rs, r1s min	= 1.5
B	= 80	S	= 70
D	= 200	Statisk belastning C0 (kN)	= 15350
D1	= 247	T	= 87
d1 min	= 320	Vægt (g)	= 35400
dK	= 365		
Dynamisk belastning C (kN)	= 9210		